

**HP 16089A, B, C Kelvin Clip Leads**

**HP 16089D Alligator Clip Leads**

# **Operation and Service Manual**



**HP Part No. 16089-90000**  
**Microfiche Part No. 16089-90050**  
**Printed in JAPAN November, 1991**

---

## Notice

The information contained in this document is subject to change without notice.

This document contains proprietary information which is protected by copyright. All rights are reserved. No part of this document may be photocopied, reproduced, or translated to another language without the prior written consent of the Hewlett-Packard Company (HP).

Yokogawa-Hewlett-Packard, LTD.  
Kobe Instrument Division  
9-1, Takakura-cho, Hachioji-shi,  
Tokyo, 192 Japan

## Warranty

This Hewlett-Packard instrument product is warranted against defects in material and workmanship for a period of one year from the date of shipment, except that in the case of certain components listed in this manual, the warranty shall be for the specified period. During the warranty period, Hewlett-Packard Company will, at its option, either repair or replace products which prove to be defective.

For warranty service or repair, this product must be returned to a service facility designed by HP. The Buyer shall prepay shipping charges to HP and HP shall pay shipping charges to return the product to the Buyer. However, the Buyer shall pay all shipping charges, duties, and taxes for products returned to HP from another country.

HP warrants that its software and firmware designed by HP for use with an instrument will execute its programming instruction when properly installed on that instrument. HP does not warrant that the operation of the instrument, or software, or firmware will be uninterrupted or error free.

## Limitation of Warranty

The foregoing warranty shall not apply to defects resulting from improper or inadequate maintenance by the Buyer, Buyer-supplied software or interfacing, unauthorized modification or misuse, operation outside of the environmental specifications for the product, or improper site preparation or maintenance.

*No other warranty is expressed or implied. HP specifically disclaims the implied warranties of merchantability and fitness for a particular purpose.*

## Certification

The Hewlett-Packard Company certifies that this product met its published specifications at the time of shipment from the factory. Hewlett-Packard further certifies that its calibration measurements are traceable to the United States National Institute of Standards and Technology, to the extent allowed by the Institute's calibration facility, or to the calibration facilities of other International Standards Organization members.

## **Exclusive Remedies**

*The remedies provided herein are the buyer's sole and exclusive remedies. HP shall not be liable for any direct, indirect, special, incidental, or consequential damages, whether based on contract, tort, or any other legal theory.*

## **Assistance**

Product maintenance agreements and other customer assistance agreements are available for Hewlett-Packard products.

If you need assistance, contact your nearest Hewlett-Packard Sales and Service Office. Addresses are provided at the back of this manual.

---

## **Manual Printing History**

The manual printing date and part number indicate its current edition. The printing date changes when a new edition is printed. (Minor corrections and updates which are incorporated at reprint do not cause the date to change.) The manual part number changes when extensive technical changes are incorporated.

November 1991. . . . First Edition

---

## Safety Summary

The following general safety precautions must be observed during all phases of operation, service, and repair of this instrument. Failure to comply with these precautions or with specific **WARNINGS** given elsewhere in this manual violates safety standards of design, manufacture, and intended use of the instrument.

*The Hewlett-Packard Company assumes no liability for the customer's failure to comply with these requirements.*

### Do NOT operate in an Explosive Atmosphere

Do *not* operate the instrument in the presence of flammable gasses or fumes. Operation of any electrical instrument in such an environment constitutes a safety hazard.

### Keep Away from Live Circuits

Operating personnel must not remove instrument covers. Component replacement and internal adjustments must be made only by qualified maintenance personnel. Do not replace components with the power cable connected. Under certain conditions, dangerous voltages may exist even with the power cable removed. To avoid injury, always disconnect power and discharge circuits before touching them.

### Do NOT Service or Adjust While Alone

Do *not* attempt internal service or adjustment unless another person, capable of turning off power and capable of rendering first aid and resuscitation, is present.

### Do NOT Substitute Parts or Modify Instrument

Because of the danger of introducing additional hazards, do *not* substitute parts or perform unauthorized modifications to the instrument. Return the instrument to a Hewlett-Packard Sales and Service Office for service and repair to ensure the safety features are maintained.

### Dangerous Procedure Warnings

Warnings, such as the example below, precede **POTENTIALLY DANGEROUS PROCEDURES** throughout this manual. Instructions contained in the **warnings** must be followed.

---

#### Warning



Dangerous voltages, capable of causing death, are present in this instrument. Use extreme caution when handling, testing, and adjusting this instrument.

---

## Safety Symbols

General definitions of safety symbols used on equipment or in manuals.



Instruction manual symbol: the product will be marked with this symbol when it is necessary for the user to refer to the instruction manual in order to protect against damage to the instrument.



Indicates dangerous voltage (terminals fed from the interior by voltage exceeding 1000 volts must be so marked).

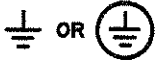

Protective ground terminal. For protection against electrical shock in case of a fault in the instrument. Used with wiring terminals to indicate the terminal which must be connected to ground before operating equipment.



Low-noise or noiseless, clean ground (earth) terminal. Used for a signal common, as well as providing protection against electrical shock in case of a fault in the instrument. A terminal marked with this symbol must be connected to ground in the manner described in the installation (Operation) manual, and before operating the equipment.

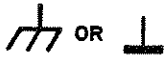

Frame or chassis terminal. A connection to the frame (chassis) of the equipment which normally includes all exposed metal structures.



Alternating current (power line).



Direct current (power line).



Alternating or direct current (power line).

### Warning



Warning denotes a hazard. It calls attention to a procedure, practice, condition or the like, which, if not correctly performed or adhered to, could result in *injury* or *death* to personnel.

### Caution



Caution sign denotes a hazard. It calls attention to a procedure, practice, condition or the like, which, if not correctly performed or adhered to, could result *damage* to or *destruction* of part or all of the product.

### Note



Note denotes important information. It calls attention to a procedure, practice, condition or the like, which is essential to highlight.

# Contents

---

<b>1. General Information</b>	
Introduction . . . . .	1-1
Using the HP 16089A, B, C, D . . . . .	1-1
Product Description . . . . .	1-1
Accessories Supplied . . . . .	1-2
Operating and Safety Precautions . . . . .	1-2
Operating . . . . .	1-2
Service . . . . .	1-2
Specifications . . . . .	1-3
Common Specifications for the HP 16089A, B, C, D . . . . .	1-3
Specifications for the HP 16089A, B, C . . . . .	1-3
Specifications for the HP 16089D . . . . .	1-3
Supplemental Performance Characteristics . . . . .	1-3
Supplemental Performance Characteristics of HP 16089A . . . . .	1-3
Supplemental Performance Characteristics of HP 16089B . . . . .	1-3
Supplemental Performance Characteristics of HP 16089C . . . . .	1-4
Supplemental Performance Characteristics of HP 16089D . . . . .	1-4
<b>2. Preparation for Use</b>	
Introduction . . . . .	2-1
Initial Inspection . . . . .	2-1
HP 16089A . . . . .	2-2
HP 16089B . . . . .	2-3
HP 16089C . . . . .	2-4
HP 16089D . . . . .	2-5
Ambient Environmental Considerations . . . . .	2-6
Operating and Storage . . . . .	2-6
Connecting the Test Leads for Use . . . . .	2-6
Packaging the Test Leads . . . . .	2-6
<b>3. Operation</b>	
Introduction . . . . .	3-1
HP 16089A, B, C . . . . .	3-1
HP 16089D . . . . .	3-2
OPEN and SHORT Correction . . . . .	3-3
Shorting Bar . . . . .	3-4
Operation . . . . .	3-4
<b>4. Service</b>	
Introduction . . . . .	4-1
Replaceable Parts . . . . .	4-1
HP 16089A Replaceable Parts . . . . .	4-1
HP 16089B Replaceable Parts . . . . .	4-1
HP 16089C Replaceable Parts . . . . .	4-2
HP 16089D Replaceable Parts . . . . .	4-3

## Figures

---

2-1. HP 16089A Product Overview . . . . .	2-2
2-2. HP 16089B Product Overview . . . . .	2-3
2-3. HP 16089C Product Overview . . . . .	2-4
2-4. HP 16089D Product Overview . . . . .	2-5
2-5. Connecting the Test Leads . . . . .	2-6
3-1. HP 16089A, B, C Test Leads Features . . . . .	3-1
3-2. HP 16089D Test Leads Features . . . . .	3-2
3-3. Making a Shorting Bar for the HP 16089B and HP 16089C . . . . .	3-3
3-4. Making a Shorting Bar for the HP 16089A and HP 16089D . . . . .	3-3
3-5. Connecting the DUT to the HP 16089D . . . . .	3-5
4-1. Kelvin Clip Connections . . . . .	4-2

## Tables

---

1-1. Furnished Accessories . . . . .	1-2
2-1. Contents of HP 16089A . . . . .	2-2
2-2. Contents of HP 16089B . . . . .	2-3
2-3. Contents of HP 16089C . . . . .	2-4
2-4. Contents of HP 16089D . . . . .	2-5
4-1. 16089A Replaceable Parts . . . . .	4-1
4-2. 16089B Replaceable Parts . . . . .	4-1
4-3. 16089C Replaceable Parts . . . . .	4-2
4-4. 16089D Replaceable Parts . . . . .	4-3
4-5. Clip and Cable Correspondence . . . . .	4-3



## General Information

---

### Introduction

The purpose of this manual is to enable you to use your HP 16089A, B, C Kelvin Clip Leads and HP 16089D Alligator Clip Leads efficiently and confidently. This manual contains both general and specific information. To use the HP 16089A, B, C, D to perform a specific function (without having to read the entire manual), follow the directions in "Using the HP 16089A, B, C, D".

---

### Using the HP 16089A, B, C, D

- To install the HP 16089A, B, C, D, turn to Chapter 2.
- To operate the HP 16089A, B, C, D, turn to Chapter 3.
- To order replaceable parts for the HP 16089A, B, C, D, turn to "Replaceable Parts" in Chapter 4.

---

### Product Description

The HP 16089A, B, C, D has been designed to operate specifically with the following four-terminal-pair type LCR meters and impedance analyzers:

HP 4263A	HP 4277A	HP 4192A
HP 4274A	HP 4278A	HP 4194A
HP 4275A	HP 4284A	
HP 4276A	HP 4285A	

The HP 16089A, B, C, D make it possible to measure odd-shaped components that cannot be measured with conventional test fixtures. The HP 16089A, HP 16089B, and HP 16089C consist of a direct attachment, four-terminal-pair type test leads that are equipped with two insulated Kelvin clips. Three sizes of Kelvin clips are provided. The HP 16089A Kelvin Clip Leads is equipped with two large Kelvin clips, the HP 16089B Kelvin Clip Leads is equipped with middle size clips and the HP 16089C Kelvin Clip Leads is equipped with small size clips. The HP 16089D consists of a direct attachment, four-terminal-pair type test leads that are equipped with four alligator clips.

---

## Accessories Supplied

The following accessories are supplied with the HP 16089A, B, C, D:

Table 1-1. Furnished Accessories

Description	Part Number	Quantity
Operation and Service Manual	P/N 16089-90000	1

---

## Operating and Safety Precautions

### Operating

You need observe only normal precautions in handling and operating the HP 16089A, B, C, D. Do not exceed the operating input power, voltage, and current level and signal type appropriate for the instrument being used, refer to your instrument's operation manual.

---

### Caution



Electrostatic discharge (ESD) can damage the highly sensitive microcircuits in your instrument. ESD damage is most likely to occur as the test leads are being connected or disconnected. Protect them from ESD damage by wearing a grounding strap that provides a high resistance path to ground. Alternatively, ground yourself to discharge any static charge built-up by touching the outer shell of any grounded instrument chassis before touching the test port connectors.

Never touch the test clip contacts.

Use a work station equipped with an anti-static work surface.

---

### Service

The voltage levels found in these test leads when used with the intended instruments do not warrant more than normal safety precautions for operator safety. Nevertheless, service should be performed only by qualified personnel.

---

## Specifications

This section lists the complete HP 16089A, B, C, D specifications. These specifications are the performance standards and limits against which the HP 16089A, B, C, D is tested. When shipped from the factory, the HP 16089A, B, C, D meets the following specifications:

### Common Specifications for the HP 16089A, B, C, D

Applicable Instrument	HP 4263A, HP 4274A <sup>1</sup> , HP 4275A, HP 4276A, HP 4277A <sup>1</sup> HP 4278A <sup>1</sup> , HP 4284A <sup>1</sup> , HP 4285A <sup>1</sup> , HP 4192A <sup>1</sup> , HP 4194A <sup>1</sup>
Maximum dc Bias Voltage	±42 V peak max
Frequency Range	5 Hz to 100 kHz
Operating Temperature	0 to 55°C
Operating Humidity	≤95% RH (@40°C)
Non-operating Temperature	-40 to 70 °C
Non-operating Humidity	≤95% RH (@40°C)
Weight	300 g

<sup>1</sup> Except for the frequency range over 100 kHz.

### Specifications for the HP 16089A, B, C

Cable Length	0.94 m
--------------	--------

### Specifications for the HP 16089D

Cable Length	1.3 m
--------------	-------

---

## Supplemental Performance Characteristics

This section gives supplemental performance characteristics. Supplemental performance characteristics are not specifications, but are typical characteristics included as additional information for the operator. Supplemental performance characteristics are not guaranteed.

### Supplemental Performance Characteristics of HP 16089A

■ Applicable DUT size

Diameter of DUT's terminals	≤15 mm
-----------------------------	--------

### Supplemental Performance Characteristics of HP 16089B

■ Applicable DUT size

Diameter of DUT's terminals	≤7.0 mm
Length of DUT's terminals	≥3 mm

## Supplemental Performance Characteristics of HP 16089C

### ■ Applicable DUT size

Diameter of DUT's terminals .....	$\leq 1$ mm
Space between DUT's terminals .....	$\geq 2$ mm
Length of DUT's terminals .....	$\geq 2$ mm

## Supplemental Performance Characteristics of HP 16089D

### ■ Applicable DUT size

Diameter of DUT's terminals .....	$\leq 5$ mm
-----------------------------------	-------------

## Preparation for Use

---

### Introduction

This chapter explains how to install the HP 16089A, B, C Kelvin Clip Leads and HP 16089D Alligator Clip Leads. The topics covered include initial inspection, ambient environmental considerations, connecting the test leads for use, and repackaging the test leads for shipment.

---

### Initial Inspection

These test leads have been carefully inspected electrically and mechanically before being shipped from the factory. They should be in perfect physical condition, no scratches, dents or the like, and they should be in perfect electrical condition. Verify this by carefully performing an incoming inspection to check the test lead set for signs of physical damage and missing contents. If any discrepancy is found, notify the carrier and Hewlett-Packard. Your HP sales office will arrange for repair and replacement without waiting for the claim to be settled.

1. Inspect the shipping container for damage, and keep the shipping materials until the inspection is completed.
2. Verify that the shipping container contains everything shown in Figure 2-1, Figure 2-2, Figure 2-3, and Figure 2-4 and listed in Table 2-1, Table 2-2, Table 2-3, and Table 2-4.
3. Inspect the exterior of the HP 16089A, B, C, D for any signs of damage.

# HP 16089A

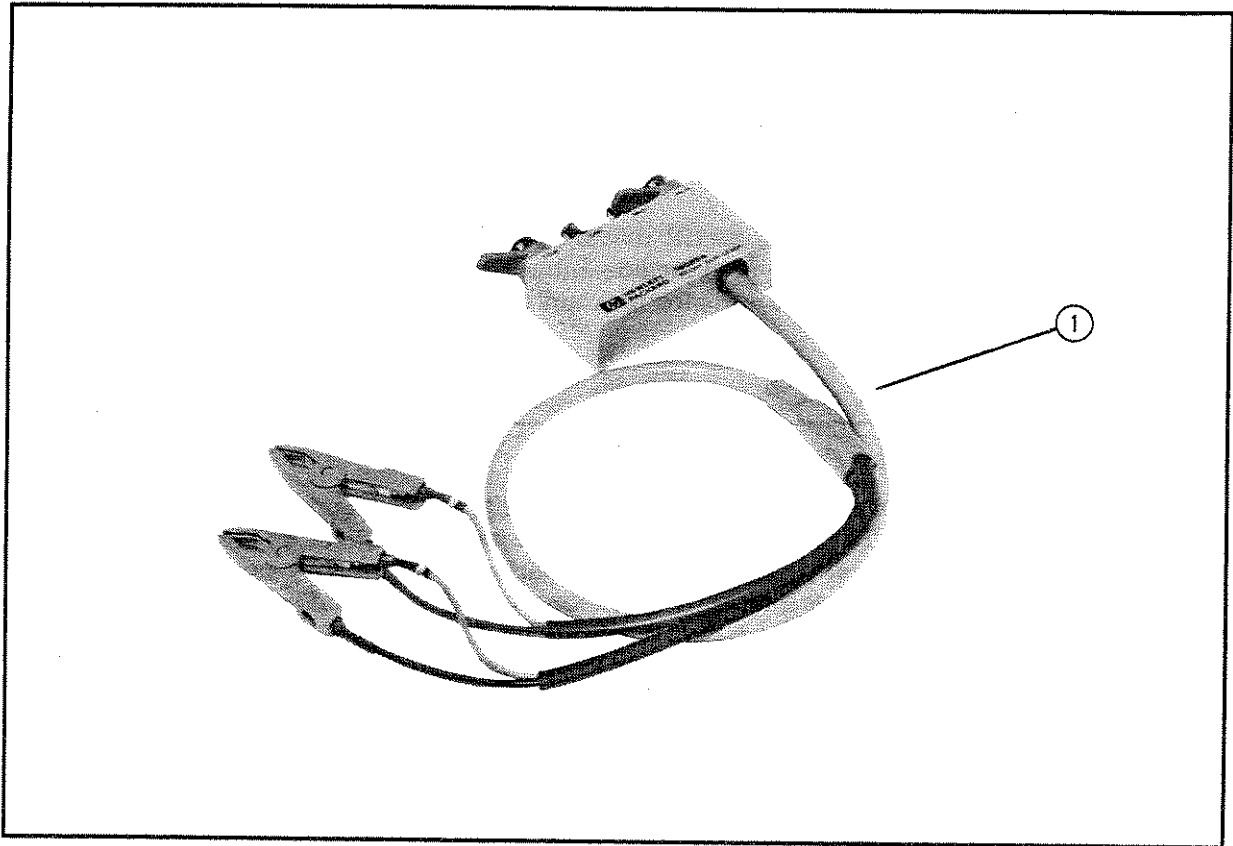

Figure 2-1. HP 16089A Product Overview

Table 2-1. Contents of HP 16089A

Description	HP Part Number	Quantity
① Kelvin Clip Leads	16089-60001	1
② Operation and Service Manual <sup>1</sup>	16089-90000	1

<sup>1</sup> Operation and Service Manual is not shown in Figure 2-1.

# HP 16089B

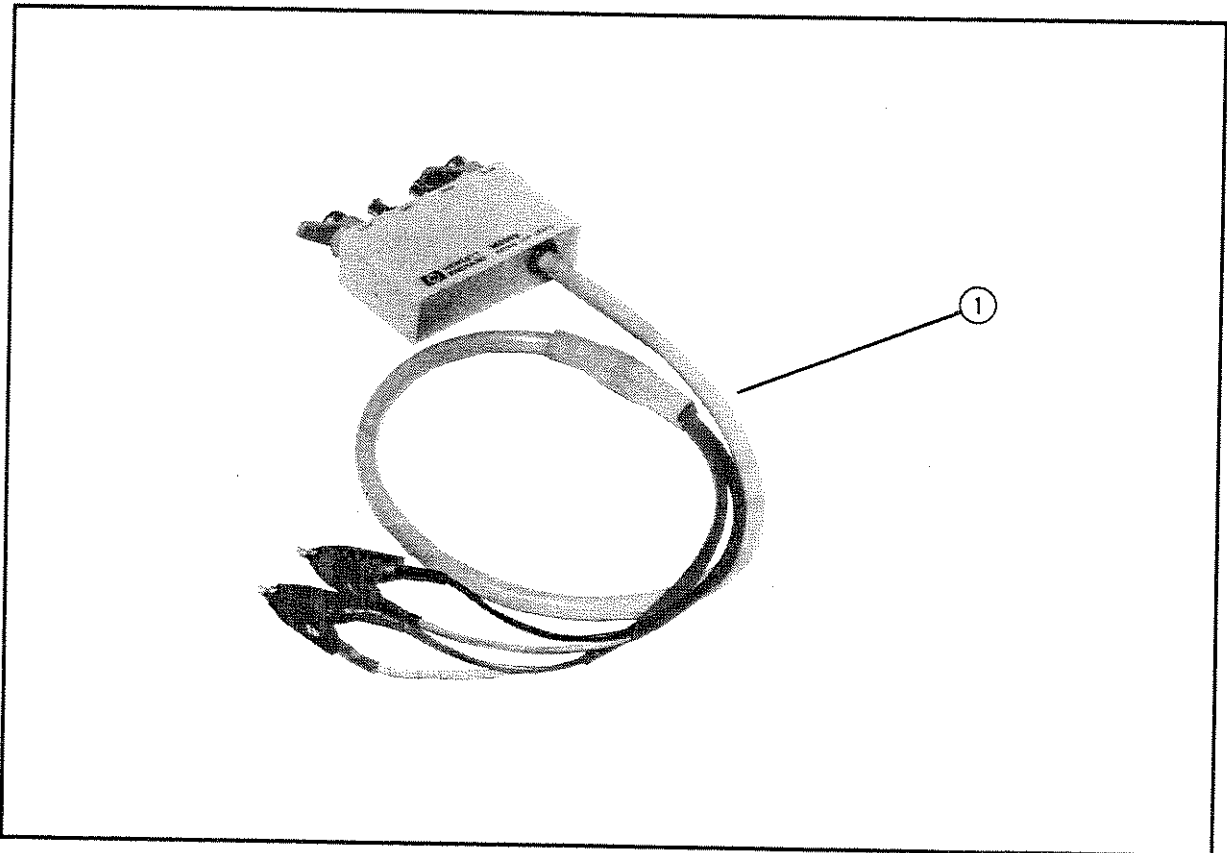

**Figure 2-2. HP 16089B Product Overview**

**Table 2-2. Contents of HP 16089B**

Description	HP Part Number	Quantity
① Kelvin Clip Leads	16089-60002	1
② Operation and Service Manual <sup>1</sup>	16089-90000	1

<sup>1</sup> Operation and Service Manual is not shown in Figure 2-2.

## HP 16089C

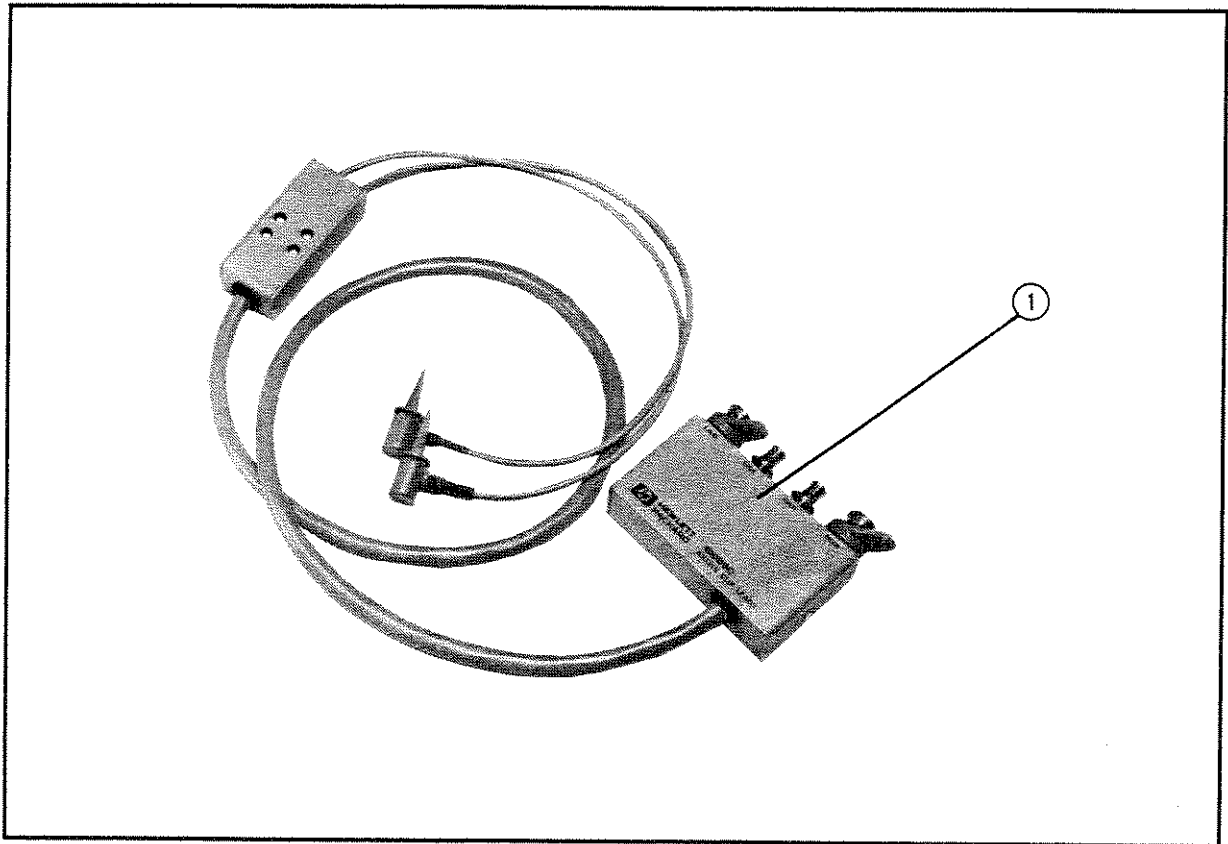

**Figure 2-3. HP 16089C Product Overview**

**Table 2-3. Contents of HP 16089C**

Description	HP Part Number	Quantity
① Kelvin Clip Leads	16089-60003	1
② Operation and Service Manual <sup>1</sup>	16089-90000	1

<sup>1</sup> Operation and Service Manual is not shown in Figure 2-3.



# HP 16089D

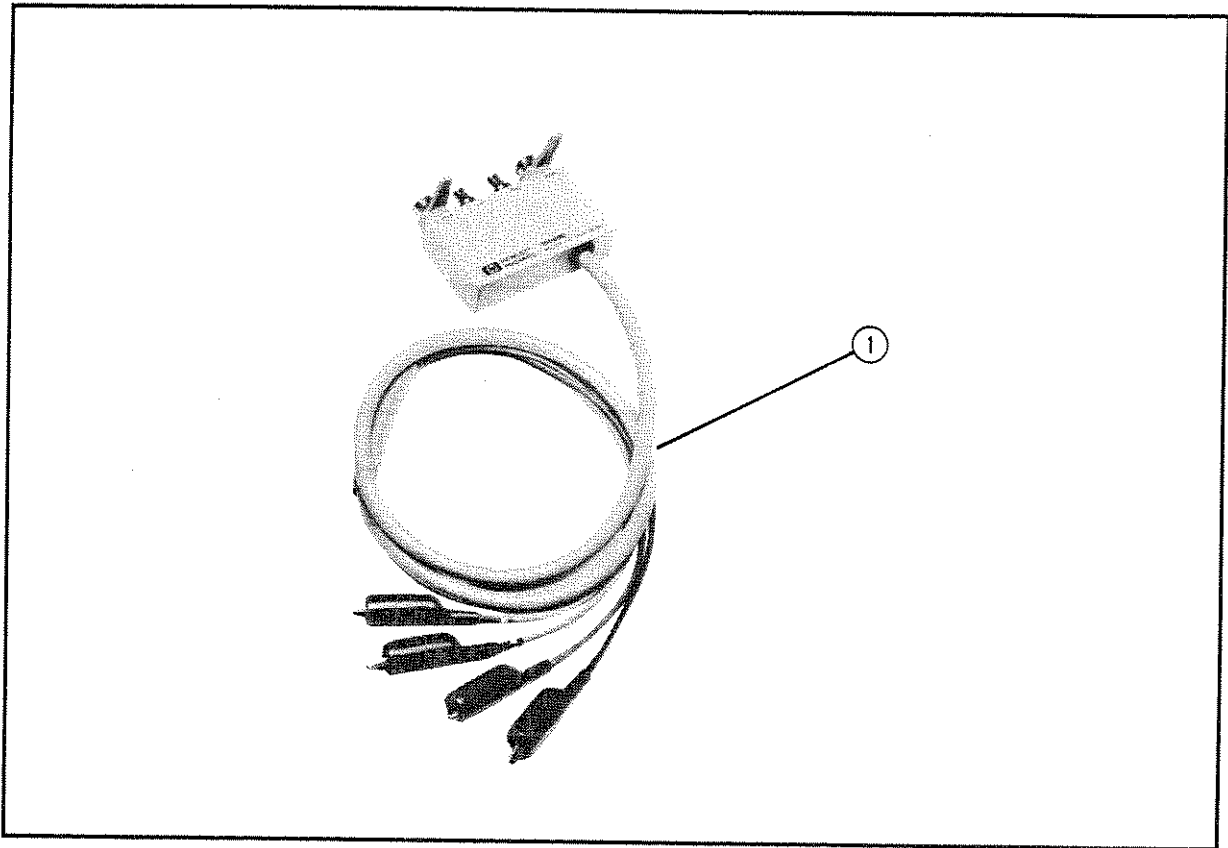

Figure 2-4. HP 16089D Product Overview

Table 2-4. Contents of HP 16089D

Description	HP Part Number	Quantity
① Alligator Clip Leads	16089-60004	1
② Operation and Service Manual <sup>1</sup>	16089-90000	1

<sup>1</sup> Operation and Service Manual is not shown in Figure 2-4.

---

## Ambient Environmental Considerations

### Operating and Storage

The HP 16089A, B, C, D must be operated within an ambient temperature range of 0°C to 55°C and relative humidity up to 95% at 40°C (non-condensing).

The HP 16089A, B, C, D may be stored within a temperature range of -40°C to +70°, and at a relative humidity of up to 95% at +40°C (non-condensing).

---

## Connecting the Test Leads for Use

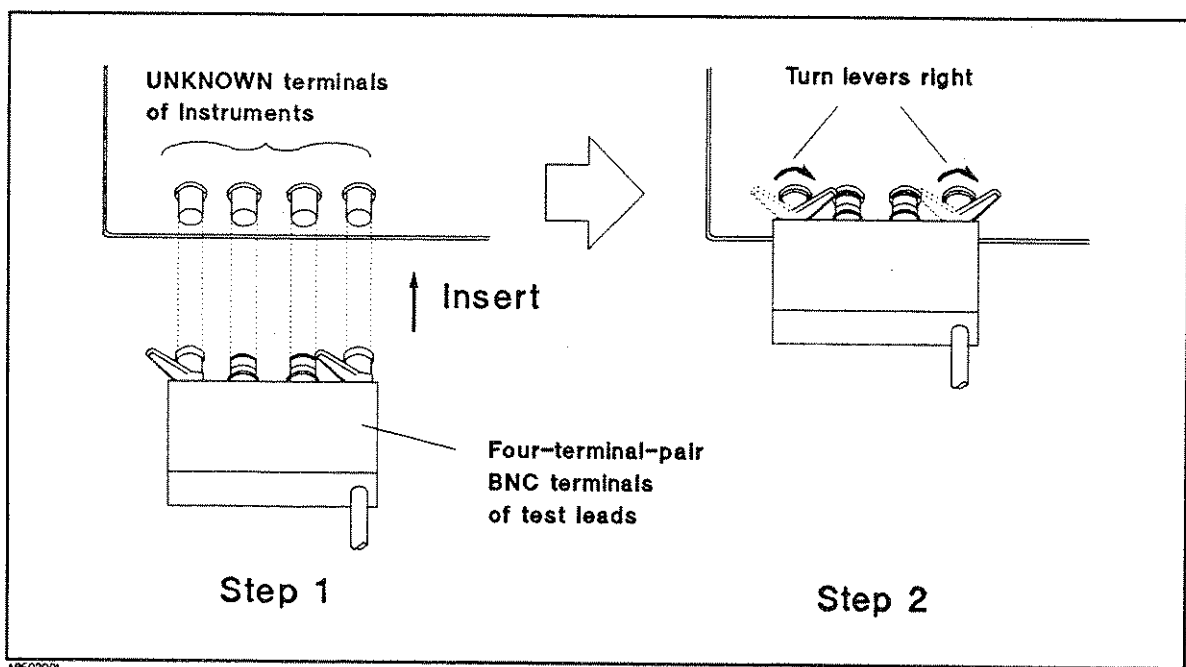

Figure 2-5. Connecting the Test Leads

---

## Packaging the Test Leads

If shipment to a Hewlett-Packard service center is required, each test lead set should be repackaged using the original factory packaging materials.

Alternatively, comparable packaging materials may be used. Wrap the test leads in heavy paper and pack in anti-static plastic packing material. Use sufficient shock absorbing material on all sides of the HP 16089A, B, C, D to provide a thick, firm cushion and to prevent movement. Seal the shipping container securely and mark it *FRAGILE*.

## Operation

### Introduction

This chapter describes using the test leads and correction techniques for these test leads.

### HP 16089A, B, C

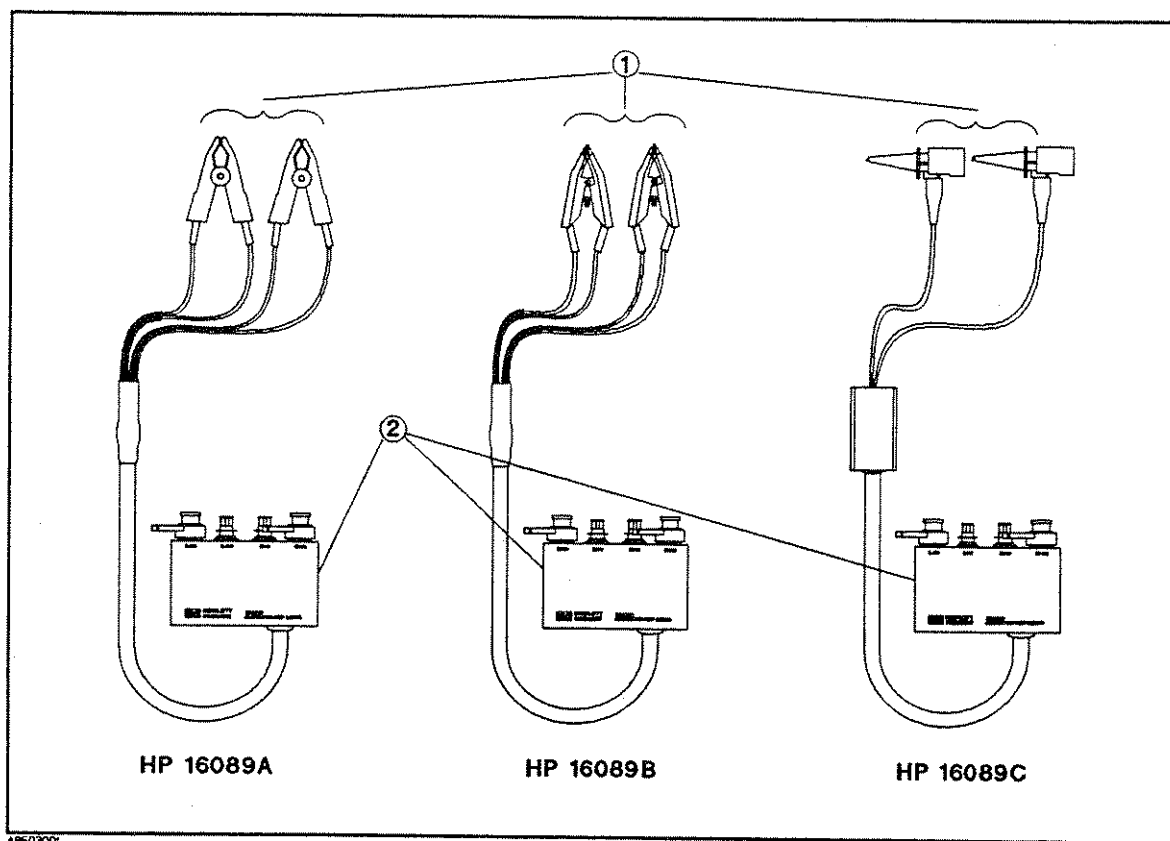

Figure 3-1. HP 16089A, B, C Test Leads Features

1. *Kelvin Clips*. These are connected to the DUT.
2. *Four-terminal-pair BNC terminals*. These terminals are connected to the UNKNOWN terminals of your measurement instrument.

## HP 16089D

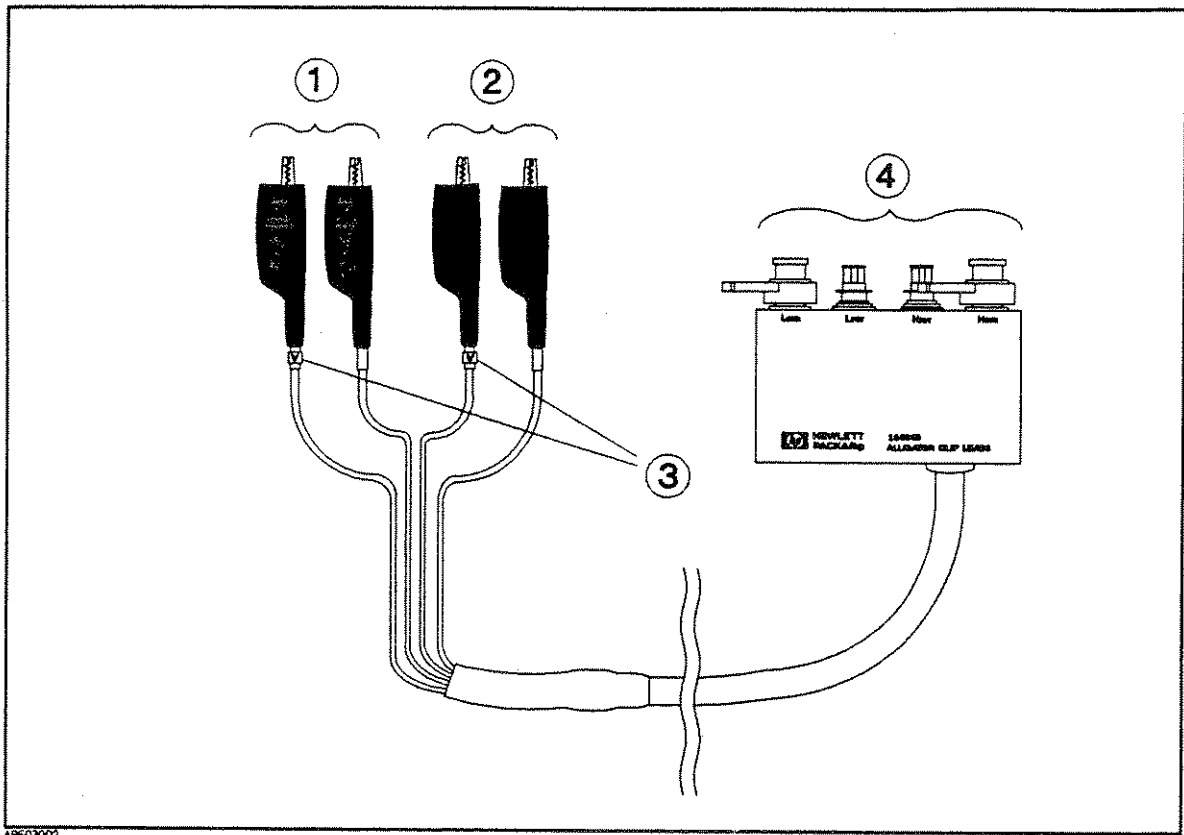

Figure 3-2. HP 16089D Test Leads Features

1. *Alligator Clips (red)*. These are connected to the high terminal of the DUT.
2. *Alligator Clips (black)*. These are connected to the low terminal of the DUT.
3. *V markers*. These show the H<sub>pot</sub> and L<sub>pot</sub> terminals.
4. *Four-terminal-pair BNC terminals*. These terminals are connected to the UNKNOWN terminals of your instrument.

## OPEN and SHORT Correction

The HP 16089A, B, C, D have inherent stray capacitance, residual inductance, and residual resistance that affect the measurement. To cancel the effects caused by these residuals and thus minimize their effect on measurement accuracy, the measurement instrument's OPEN and SHORT correction capabilities must be used. The procedures are described in the measurement instrument's operation manual.

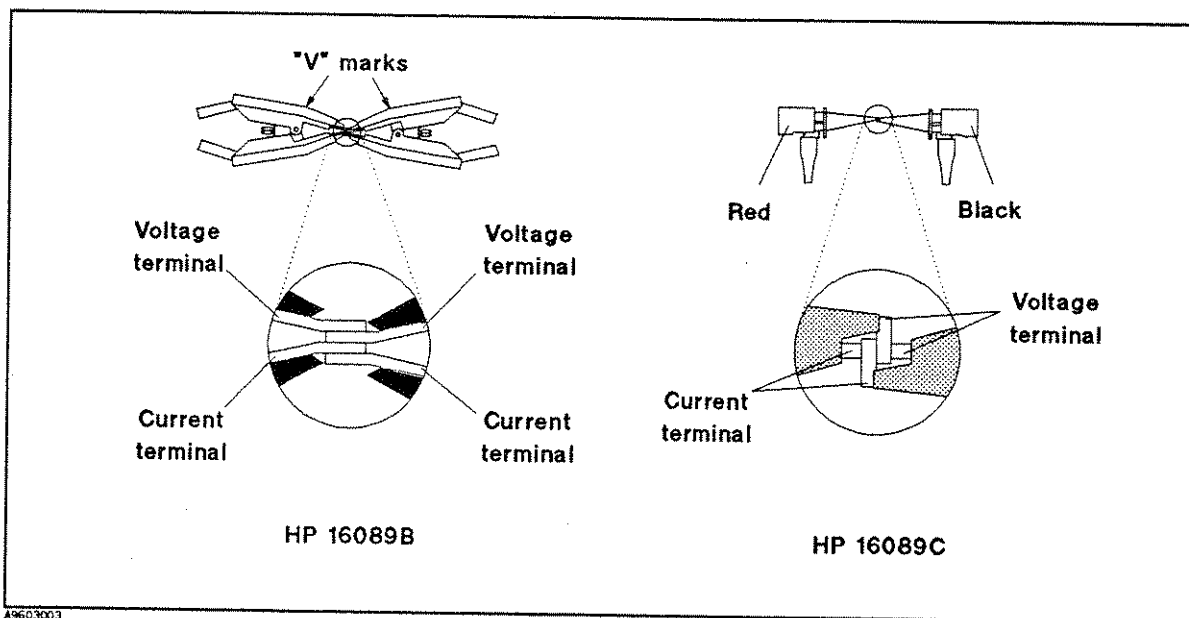

Figure 3-3. Making a Shorting Connection for the HP 16089B and HP 16089C

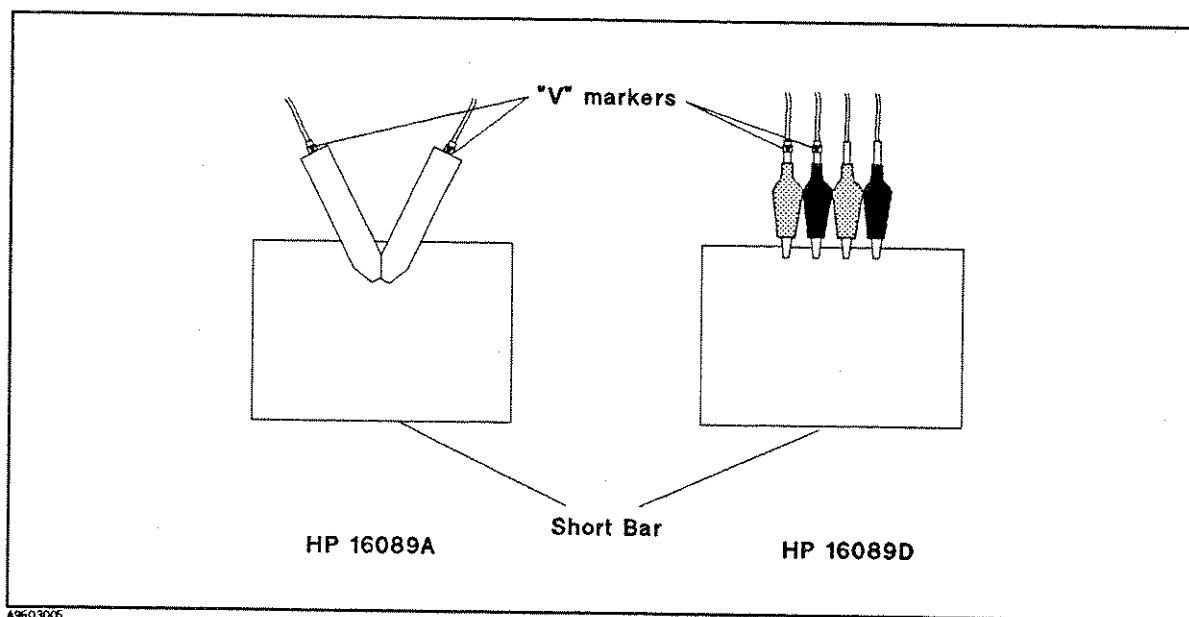

Figure 3-4. Making a Shorting Connection for the HP 16089A and HP 16089D

## Shorting Bar

The short bar should have very low residual impedance, so a high conductivity metal plate that is not easily corroded, must be used to construct the shorting bar. (It must be clean.)

---

## Operation

Step-by-step instructions on how to make a measurement with the HP 16089A, B, C, D are:

1. Set the Cable Length setting to 1 m.  
(HP 4263A, HP 4275A, HP 4277A, HP 4192A, HP 4278A, HP 4284A and HP 4285A only)
2. Connect the test leads of HP 16089A, B, C, D to the measurement Instrument's UNKNOWN terminals.
3. Perform OPEN and SHORT correction as described in the measurement instrument's operation manual. Figure 3-3 and Figure 3-4 show how to make shorts suitable for the SHORT correction procedure using each type of test clip.  
(HP 4263A, HP 4275A, HP 4276A, HP 4192A, HP 4278A, HP 4284A and HP 4285A only)
4. Connect the component to be tested into the test clips.

---

### Note



When HP 16089D is used, connect the test clips to the DUT correctly as follows:

- Connect all test clips to the DUT.
- Connect the same color test clips to the same terminal of the DUT.
- Connect the  $H_{pot}$  and  $L_{pot}$  clips (marked "V") closer to the DUT than  $H_{cur}$  and  $L_{cur}$  clips.

Figure 3-5 also shows how to connect a DUT using the alligator clips of the HP 16089D.

---

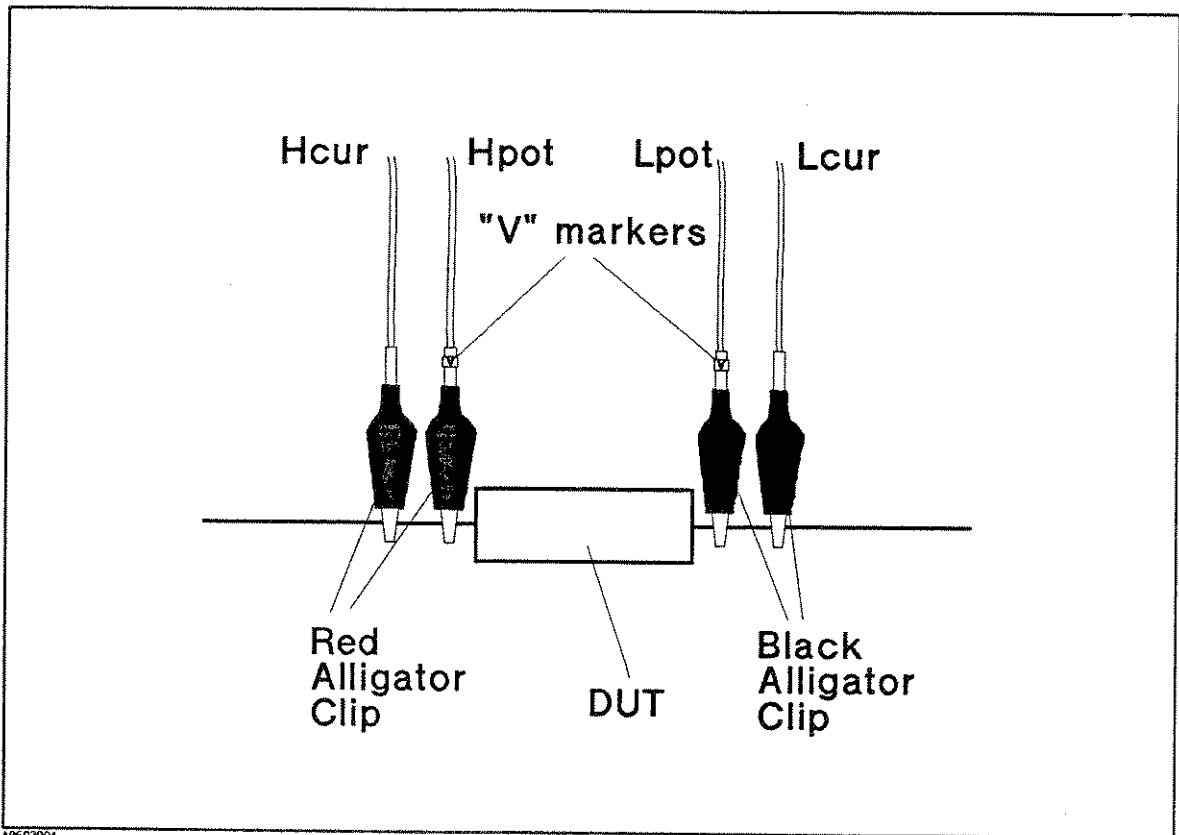

Figure 3-5. Connecting the DUT to the HP 16089D





## Service

---

### Introduction

This chapter gives replaceable parts information for the HP 16089A, HP 16089B, HP 16089C, and HP 16089D.

### Replaceable Parts

Table 4-1, Table 4-2, Table 4-3, and Table 4-4 list the replaceable parts for the HP 16089A, B, C, and D, respectively. Figure 4-1 shows the connection from the cable to the clip assembly of the HP 16089C. The parts listed can be ordered from your nearest Hewlett-Packard office. Ordering information should include the HP part number and the quantity required.

#### HP 16089A Replaceable Parts

Table 4-1. 16089A Replaceable Parts

HP Part Number	Qty.	Description
16089-60001	1	Test Leads <sup>1</sup>
16089-04001	1	Cover Top
0515-0914	2	Screw Flat Head M3×0.5 L6
16089-60011	2	Large Clip Assembly
7121-2696	2	Wire Marker "V"

<sup>1</sup> The whole unit.

Red and orange cables are screwed on the one Kelvin clip assembly. Gray and black cables are screwed on the other Kelvin clip assembly. Orange and gray cables are marked "V".

#### HP 16089B Replaceable Parts

Table 4-2. 16089B Replaceable Parts

HP Part Number	Qty.	Description
16089-60002	1	Test Leads <sup>1</sup>
16089-04002	1	Cover Top
0515-0914	2	Screw Flat Head M3×0.5 L6
16005-60010	2	Kelvin Clip Assembly

<sup>1</sup> The whole unit.

On one Kelvin clip, the orange cable is screwed on the "V" marked side, and the red cable is screwed on the non-marked side. On the other Kelvin clip, the gray cable is screwed on the "V" marked side, and the black cable is screwed on the non-marked side.

## HP 16089C Replaceable Parts

Table 4-3. 16089C Replaceable Parts

Reference <sup>1</sup> Designator	HP Part Number	Qty.	Description
1	16089-60003	1	Test Leads <sup>2</sup>
	16089-04003	1	Cover Top
	0515-0914	2	Screw Flat Head M3×0.5 L6
	16005-60013	1	Test Clip Assembly Red
	16005-60015	1	Test Clip Assembly Black
2	0890-1809	2 cm	Tube Heat Shrinkable Red
	0890-1808	2 cm	Tube Heat Shrinkable Black

1 Corresponding to designator in Figure 4-1.

2 The whole unit.

Connection from the cables to the Kelvin clip is shown in Figure 4-1.

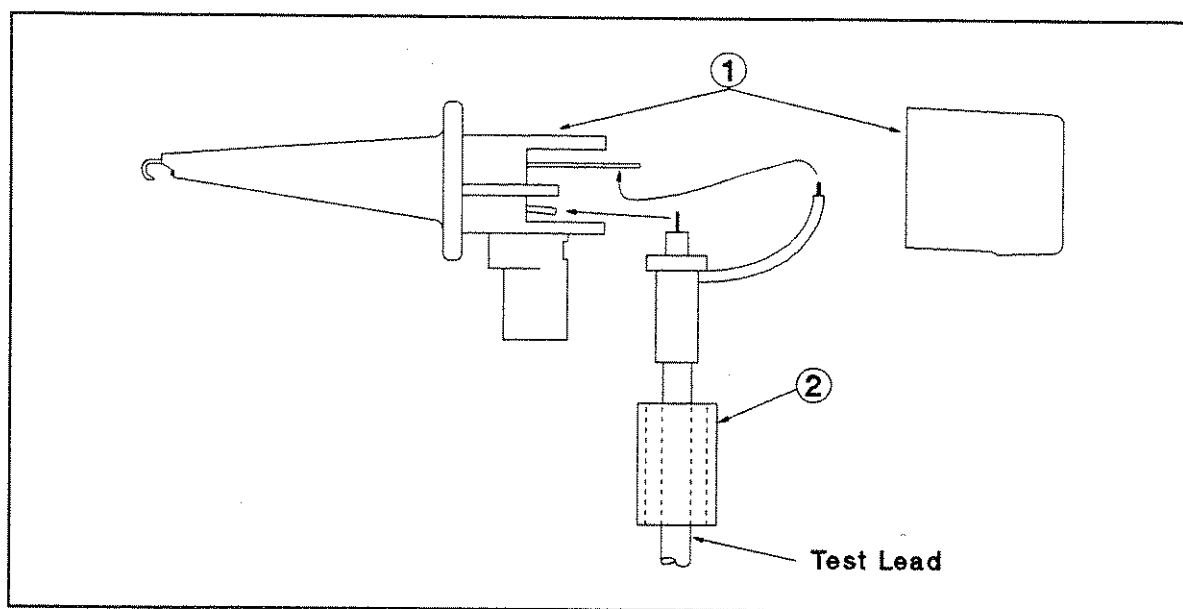

AS605001

Figure 4-1. Kelvin Clip Connections

## HP 16089D Replaceable Parts

Table 4-4. 16089D Replaceable Parts

HP Part Number	Qty.	Description
16089-60004	1	Test Leads <sup>1</sup>
16089-04004	1	Cover Top
0515-0914	2	Screw Flat Head M3×0.5 L6
0340-1085	2	Insulator Alligator Clip Red
0340-1086	2	Insulator Alligator Clip Black
1400-1252	4	Alligator Clip
7121-2696	2	Wire Marker "V"

<sup>1</sup> The whole unit.

Table 4-5 shows the correspondence between the Alligator Clips and the Cables.

Table 4-5. Clip and Cable Correspondence

Alligator Clip Color	Cable Color Marker
Red	Orange "V"
Red	Red
Black	Gray "V"
Black	Black



## REGIONAL SALES AND SUPPORT OFFICES

*For information relating to Sales or Support of Hewlett-Packard products first contact your local Hewlett-Packard office listed in the white pages of your telephone directory. If none is listed locally, contact one of the addresses listed below to obtain the address or phone number of the Hewlett-Packard Sales or Support office nearest you.*

### ASIA

Hewlett-Packard Asia Ltd.  
47/F, 26 Harbour Road,  
Wanchai, HONG KONG  
G.P.O. Box 863, Hong Kong  
Tel: (852)5-8330833  
Telex: 76793 HPA HX  
Cable HPASIAL TD

### AUSTRALASIA

Hewlett-packard Australia Ltd.  
31-41 Joseph Street  
BLACKBURN, Victoria 3130  
Australia  
Tel: (61)895-2895  
Telex: 31-024  
Cable: HEWPARD Melbourne

### CANADA

Hewlett-Packard (Canada) Ltd.  
6877 Goreway Drive  
MISSISSAUGA, Ontario L4V 1M8  
Tel: (416)678-9430  
Telex: 069-8644

### JAPAN

Yokogawa-Hewlett-Packard Ltd.  
29-21 Takaido-Higashi, 3 Chome  
Suginami-ku TOKYO 168  
Tel: 03(331)6111  
Telex: 232-2024 YHPTOK

### MEDITERRANEAN AND MIDDLE EAST

Hewlett-Packard S.A.  
Mediterranean and Middle East  
Operations  
Atrina Centre  
32 Kifissias Avenue  
Paradissos-Amarousion, ATHENS  
Greece  
Tel: (30)682 88 11  
Telex: 21-6588 HPAT GR  
Cable: HEWPACKSA Athens

May, 1990

### BENELUX & SCANDINAVIA

Hewlett-Packard S.A.  
Uilenstede 475  
P.O. Box 999  
NL-1183 AG AMSTELVEEN  
The Netherlands  
Tel: (31)20/43 77 71  
Telex: 18 919 hpner nl

### SOUTH & EAST EUROPE, AFRICA

Hewlett-Packard S.A.  
7 rue du Bois-du-Lan  
CH-1217 MEYRIN 2, Geneva  
Switzerland  
Tel: (41)22/83 12 12  
Telex: 27835 hmea  
Cable: HEWPACKSA Geneva

### FRANCE

Hewlett-Packard France  
Parc d'activites du Bois Briard  
2, avenue du Lac  
91040 EVRY Cedex  
Tel: 1 6/077 83 83  
Telex: 6923 15F

### GERMAN FEDERAL REPUBLIC

Hewlett-Packard GmbH  
Hewlett-Packard-Strasse  
Postfach 1641  
D-6380 BAD HOMBURG  
West Germany  
Tel: 06172/400-0  
Telex: 410 844 hpbhg

### ITALY

Hewlett-Packard Italiana S.p.A.  
Via G. Di Vittorio 9  
1-20063 CERNUSCO SUL  
NAVIGLIO  
(Milano)  
Tel: 02/92 36-91  
Telex: 334632

### UNITED KINGDOM

Hewlett-Packard Ltd.  
King Street Lane  
Winnersh, WOKINGHAM  
Berkshire RG11 5AR  
Tel: 734/78/ 47 74  
Telex: 847178

### EASTERN USA

Hewlett-Packard Co.  
4 Choke Cherry Road  
ROCKVILLE, MD 20850  
TEL: (301)670-4300

### MIDWESTERN USA

Hewlett-Packard Co.  
5201 Tollview Drive  
ROLLING MEADOWS, IL 6008  
Tel: (312)255-9800

### SOUTHERN USA

Hewlett-Packard Co.  
2000 South Park Place  
P.O. Box 105005  
ATLANTA, GA 30348  
Tel: (404)955-1500

### WESTERN USA

Hewlett-Packard Co.  
5161 Lankershim Blvd.  
P.O. Box 3919  
NO. HOLLYWOOD, CA 91609  
Tel: (818)506-3700

### OTHER INTERNATIONAL AREAS

Hewlett-Packard Co.  
Intercontinental Headquarters  
3495 Deer Creek Road  
PALO ALTO, CA 94304  
Tel: (415)857-1501  
Telex: 034-8300  
Cable: HEWPACK

